



IMPORTANT SAFETY INSTRUCTIONS

1. Read carefully before installing fixture. Retain for future reference.

⚠ WARNING To prevent electrical shock, turn off electricity at fuse box before proceeding.

2. Failure to follow instructions may result in serious injury or death.

3. Upon receipt the fixture, thoroughly inspect for any freight damage which should be brought to the attention of the delivery carrier. Compare the catalog description listed on the package slip with the fixture label on the housing to assure you have received material.

4. This fixture must be wired in accordance with the international electrical code and applicable local codes and ordinances. Proper grounding is required to insure personal safety. Carefully observe the correct grounding procedure under installation section.

5. DECO luminaires may be damaged if connected to conduit systems containing water - Article 300-5G of National Electric Code requires that "Conduits or raceways through which moisture may contact energized live parts shall be sealed or plugged at either or both ends".

6. In conformance with UL Standard 1598, a silicone based sealant must be used between luminaire and supporting wall.

7. Wall applications only.

8. Luminaire mounts directly to the wall or ceiling over a 3 1/2" or 4" standard octagonal wiring box (by others).

9. Installation should be performed by at least 2 people.

10. It is recommended that the luminaire not be mounted at a height less than 12' above finished floor.

****Note: Luminaire must be installed before ceiling!****

*Deco Digital assumes no responsibility for claims arising out of improper or careless handling or installation of this product.

Installing Canopy

1. Undo (4) screws at luminaire faceplate and remove.

2. Make supply wiring and luminaire wiring connections inside the wiring box:

MAIN VOLTAGE SUPPLY WIRE TO BLACK LUMINAIRE WIRE NEUTRAL (COMMON) SUPPLY WIRE TO WHITE LUMINAIRE WIRE

GREEN GROUND WIRE TO GREEN LUMINAIRE WIRE.

Deco Lighting practices a program of continuous product improvement, and as a result product specifications change frequently. We reserve the right to change product specifications without notice. Contact Deco for the latest product information.

D537-LED

LED Canopy Light

Installation Guide



3. Note orientation labels on mounting plate and position on wall mounting surface.
4. Mount plate directly to the wall or to junction box using hardware (by others).
5. Place a small bead of silicone around the back side of the luminaire base that will come in contact with the finished wall.
6. Insert fixture.
7. Make sure gasket is seated properly.
8. Place faceplate onto housing and tighten screws firmly and evenly.

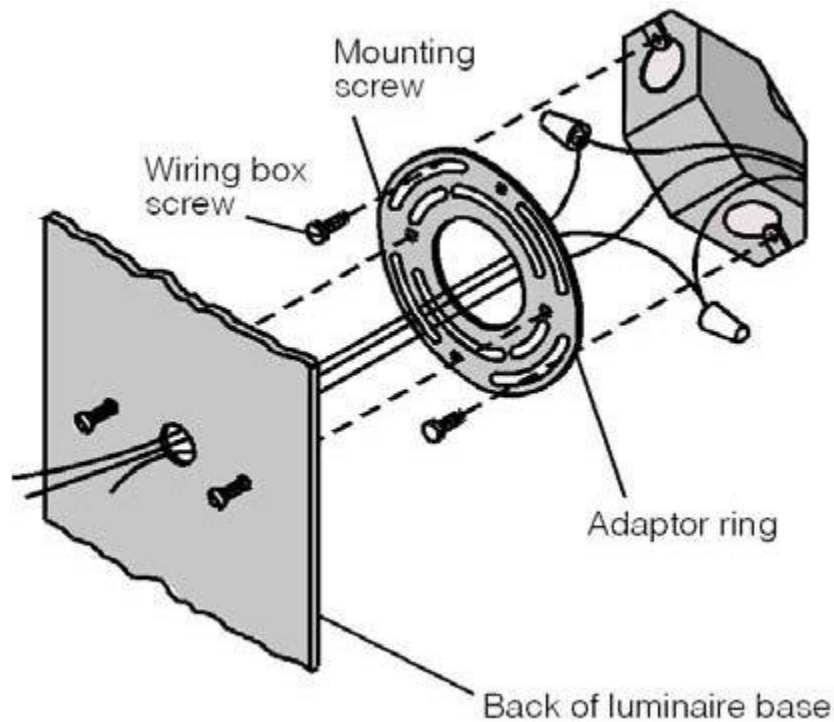

Deco Lighting practices a program of continuous product improvement, and as a result product specifications change frequently. We reserve the right to change product specifications without notice. Contact Deco for the latest product information.